

# BOSTITCH®

## N88WW/N88RH

PNEUMATIC STICK NAILER  
CLAVADORA NEUMÁTICA ALIMENTADA POR BARRA  
CLOUEUR PNEUMATIQUE À CARTOUCHE

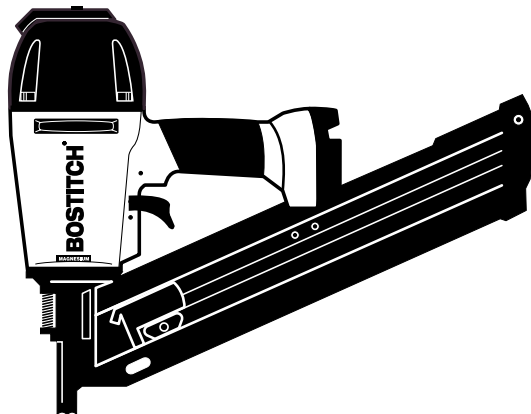

### OPERATION and MAINTENANCE MANUAL MANUAL DE OPERACIÓN Y DE MANTENIMIENTO MANUEL D'INSTRUCTIONS ET D'ENTRETIEN

**▲WARNING:**

**▲ADVERTENCIA:**

**▲ATTENTION:**

BEFORE OPERATING THIS TOOL, ALL OPERATORS SHOULD STUDY THIS MANUAL TO UNDERSTAND AND FOLLOW THE SAFETY WARNINGS AND INSTRUCTIONS. KEEP THESE INSTRUCTIONS WITH THE TOOL FOR FUTURE REFERENCE. IF YOU HAVE ANY QUESTIONS, CONTACT YOUR BOSTITCH REPRESENTATIVE OR DISTRIBUTOR.

ANTES DE OPERAR ESTA HERRAMIENTA, TODOS LOS OPERADORES DEBERÁN ESTUDIAR ESTE MANUAL PARA PODER COMPRENDER Y SEGUIR LAS ADVERTENCIAS SOBRE SEGURIDAD Y LAS INSTRUCCIONES. MANTENGA ESTAS INSTRUCCIONES CON LA HERRAMIENTA PARA FUTURA REFERENCIA, SI TIENE ALGUNA DUDA, COMUNÍQUESE CON SU REPRESENTANTE DE BOSTITCH O CON SU DISTRIBUIDOR.

LIRE ATTENTIVEMENT LE PRÉSENT MANUEL AVANT D'UTILISER L'APPAREIL. PRÊTER UNE ATTENTION TOUTE PARTICULIÈRE AUX CONSIGNES DE SÉCURITÉ ET AUX AVERTISSEMENTS. GARDER CE MANUEL AVEC L'OUTIL POUR FUTUR RÉFÉRENCE. SI VOUS AVEZ DES QUESTIONS, CONTACTEZ VOTRE REPRÉSENTANT OU VOTRE CONCESSIONNAIRE BOSTITCH.

# INTRODUCTION

---

The Bostitch N88 is a precision-built tool, designed for high speed, high volume nailing. These tools will deliver efficient, dependable service when used correctly and with care. As with any fine power tool, for best performance the manufacturer's instructions must be followed. Please study this manual before operating the tool and understand the safety warnings and cautions. The instructions on installation, operation and maintenance should be read carefully, and the manual kept for reference. NOTE: Additional safety measures may be required because of your particular application of the tool. Contact your Bostitch representative or distributor with any questions concerning the tool and its use. Bostitch, Inc., East Greenwich, Rhode Island 02818.

# INDEX

---

Safety Instructions .....	3
Tool Specifications .....	4
Air Supply: Fittings, Hoses, Filters, Air Consumption, Regulators, Operating Pressure, Setting Correct Pressure .....	5
Lubrication .....	5
Loading the Tool, Fastener Depth Control Adjustment .....	6
Removing Nails, Directional Exhaust .....	7
Tool Operation .....	8 & 9
Maintaining the Pneumatic Tool .....	10
Trouble Shooting .....	11
Driver Maintenance .....	12

# NOTE:

---

Bostitch tools have been engineered to provide excellent customer satisfaction and are designed to achieve maximum performance when used with precision Bostitch fasteners engineered to the same exacting standards. **Bostitch cannot assume responsibility for product performance if our tools are used with fasteners or accessories not meeting the specific requirements established for genuine Bostitch nails, staples and accessories.**



# LIMITED WARRANTY

---

Bostitch, Inc., warrants to the original retail purchaser that this product is free from defects in material and workmanship, and agrees to repair or replace, at Bostitch's option, any defective product within 1 year from the date of purchase. This warranty is not transferable. It only covers damage resulting from defects in material or workmanship, and it does not cover conditions or malfunctions resulting from normal wear, neglect, abuse, accident or repairs attempted or made by other than our regional repair center or authorized warranty service center. Driver blades, bumpers and o-rings are considered normally wearing parts.

**THIS WARRANTY IS IN LIEU OF ALL OTHER EXPRESS WARRANTIES. ANY WARRANTY OF MERCHANTABILITY OR FITNESS FOR A PARTICULAR PURPOSE IS LIMITED TO THE DURATION OF THIS WARRANTY. BOSTITCH SHALL NOT BE LIABLE FOR ANY INCIDENTAL OR CONSEQUENTIAL DAMAGES.**

This warranty is limited to sales in the United States and Canada. Some states do not allow limitations on how long an implied warranty lasts, or the exclusion or limitation of incidental or consequential damages, so the above limitations or exclusions may not apply to you. This warranty gives you specific legal rights, and you may also have other rights which vary from state to state.

To obtain warranty service, return the product at your expense together with proof of purchase to a Bostitch Regional or authorized warranty repair center. You may call us at 1-800-556-6696 for the location of authorized warranty service centers in your area.

# SAFETY INSTRUCTIONS

**⚠ WARNING:** **EYE PROTECTION** which conforms to ANSI specifications and provides protection against flying particles both from the FRONT and SIDE should ALWAYS be worn by the operator and others in the work area when loading, operating or servicing this tool. Eye protection is required to guard against flying fasteners and debris, which could cause severe eye injury.



The employer and/or user must ensure that proper eye protection is worn. Eye protection equipment must conform to the requirements of the American National Standards Institute, ANSI Z87.1-1989 and provide both frontal and side protection. NOTE: Non-side shielded spectacles and face shields alone do not provide adequate protection.



**CAUTION: ADDITIONAL SAFETY PROTECTION** will be required in some environments. For example, the working area may include exposure to noise level which can lead to hearing damage. The employer and user must ensure that any necessary hearing protection is provided and used by the operator and others in the work area. Some environments will require the use of head protection equipment. When required, the employer and user must ensure that head protection conforming to ANSI Z89.1 1986 is used.

## AIR SUPPLY AND CONNECTIONS

**⚠ WARNING:** Do not use oxygen, combustible gases, or bottled gases as a power source for this tool as tool may explode, possibly causing injury.

**⚠ WARNING:** Do not use supply sources which can potentially exceed 200 P.S.I.G. as tool may burst, possibly causing injury.

**⚠ WARNING:** The connector on the tool must not hold pressure when air supply is disconnected. If a wrong fitting is used, the tool can remain charged with air after disconnecting and thus will be able to drive a fastener even after the air line is disconnected possibly causing injury.

**⚠ WARNING:** Do not pull trigger or depress contact arm while connected to the air supply as the tool may cycle, possibly causing injury.

**⚠ WARNING:** Always disconnect air supply: 1.) Before making adjustments; 2.) When servicing the tool; 3.) When clearing a jam; 4.) When tool is not in use; 5.) When moving to a different work area, as accidental actuation may occur, possibly causing injury.

## LOADING TOOL

**⚠ WARNING:** When loading tool: 1.) Never place a hand or any part of body in fastener discharge area of tool; 2.) Never point tool at anyone; 3.) Do not pull the trigger or depress the trip as accidental actuation may occur, possibly causing injury.

## OPERATION

**⚠ WARNING:** Always handle the tool with care: 1.) Never engage in horseplay; 2.) Never pull the trigger unless nose is directed toward the work; 3.) Keep others a safe distance from the tool while tool is in operation as accidental actuation may occur, possibly causing injury.

**⚠ WARNING:** The operator must not hold the trigger pulled on contact arm tools except during fastening operation as serious injury could result if the trip accidentally contacted someone or something, causing the tool to cycle.

**⚠ WARNING:** Keep hands and body away from the discharge area of the tool. A contact arm tool may bounce from the recoil of driving a fastener and an unwanted second fastener may be driven possibly causing injury.

**⚠ WARNING:** Check operation of the contact arm mechanism frequently. Do not use the tool if the arm is not working correctly as accidental driving of a fastener may result. Do not interfere with the proper operation of the contact arm mechanism.

**⚠ WARNING:** Do not drive fasteners on top of other fasteners or with the tool at an overly steep angle as this may cause deflection of fasteners which could cause injury.

**⚠ WARNING:** Do not drive fasteners close to the edge of the work piece as the wood may split, allowing the fastener to be deflected possibly causing injury.

## MAINTAINING THE TOOL

**⚠ WARNING:** When working on air tools note the warnings in this manual and use extra care when evaluating problem tools.

# N88 TOOL SPECIFICATIONS

All screws and nuts are metric.

MODEL	TOOL ACTUATION	LENGTH	HEIGHT	WIDTH	WEIGHT
N88WW-1	Contact Trip	18-3/8" (467mm)	13-13/16" (351mm)	4-7/8" (124mm)	7.8lb. (3.5kg.)
N88WW-2	Sequential Trip	18-3/8" (467mm)	13-13/16" (351mm)	4-7/8" (124mm)	7.8lb. (3.5kg.)
N88RH-1	Contact Trip	19-7/8" (505mm)	14-1/4" (362mm)	4-7/8" (124mm)	7.9lb. (3.6kg.)
N88RH-2	Sequential Trip	19-7/8" (505mm)	14-1/4" (362mm)	4-7/8" (124mm)	7.9lb. (3.6kg.)

## FASTENER SPECIFICATIONS:

### N88WW

This tool uses a 28° wire collated stick nail in lengths of 2" to 3-1/2" (50 - 90mm) and shank diameters of .113" to .131" (2.8 - 3.3mm)

### N88RH

This tool uses a 21° plastic collated full round head stick nail in lengths of 2" to 3-1/2" (50 - 90mm) and shank diameters of .113" to .162" (2.8 - 4.1mm)

## TOOL AIR FITTING:

This tool uses a 1/4" N.P.T. male plug. The inside diameter should be .275" (7mm) or larger. The fitting must be capable of discharging tool air pressure when disconnected from the air supply.

## OPERATING PRESSURE:

70 to 120 p.s.i.g. (4.9 to 8.4 kg/cm<sup>2</sup>). Select the operating pressure within this range for best fastener performance. **DO NOT EXCEED THIS RECOMMENDED OPERATING PRESSURE.**

## AIR CONSUMPTION:

The N88 requires 7.5 cubic feet per minute (212 liters per minute) of free air to operate at the rate of 100 nails per minute, at 80 p.s.i. (5.6 kg/cm<sup>2</sup>). Take the actual rate at which the tool will be run to determine the amount of air required. For instance, if your fastener usage averages 50 nails per minute, you need 50% of the 7.5 c.f.m. (212 liters per minute) which is required to operate the tool at 100 nails per minute.

# OPERATION

BOSTITCH OFFERS TWO TYPES OF OPERATION FOR THIS SERIES TOOL

## CONTACT TRIP

The common operating procedure on "Contact Trip" tools is for the operator to contact the work to actuate the trip mechanism while keeping the trigger pulled, thus driving a fastener each time the work is contacted. This will allow rapid fastener placement on many jobs, such as sheathing, decking and pallet assembly.

All pneumatic tools are subject to recoil when driving fasteners. The tool may bounce, releasing the trip, and if unintentionally allowed to recontact the work surface with the trigger still actuated (finger still holding trigger pulled) an unwanted second fastener will be driven.

## SEQUENTIAL TRIP

The Sequential Trip requires the operator to hold the tool against the work before pulling the trigger. This makes accurate fastener placement easier, for instance on framing, toe nailing and crating applications.

The Sequential Trip allows exact fastener location without the possibility of driving a second fastener on recoil, as described under "Contact Trip".

The Sequential Trip Tool has a positive safety advantage because it will not accidentally drive a fastener if the tool is contacted against the work – or anything else – while the operator is holding the trigger pulled.

## MODEL IDENTIFICATION:

Refer to Operation Instructions on page 4 before proceeding to use this tool.

**CONTACT TRIP**  
Identified by:  
**BLACK TRIGGER**

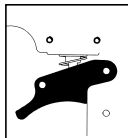

**SEQUENTIAL TRIP**  
Identified by:  
**GRAY TRIGGER**

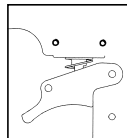

## AIR SUPPLY AND CONNECTIONS

---

**▲WARNING:** Do not use oxygen, combustible gases, or bottled gases as a power source for this tool as tool may explode, possibly causing injury.

### **FITTINGS:**

Install a male plug on the tool which is free flowing and which will release air pressure from the tool when disconnected from the supply source.

### **HOSES:**

Air hoses should have a minimum of 150 p.s.i. (10.6 kg/cm<sup>2</sup>) working pressure rating or 150 percent of the maximum pressure that could be produced in the air system. The supply hose should contain a fitting that will provide "quick disconnecting" from the male plug on the tool.

### **SUPPLY SOURCE:**

Use only clean regulated compressed air as a power source for this tool. **NEVER USE OXYGEN, COMBUSTIBLE GASES, OR BOTTLED GASES, AS A POWER SOURCE FOR THIS TOOL AS TOOL MAY EXPLODE.**

### **REGULATOR:**

A pressure regulator with an operating pressure of 0 - 125 p.s.i. (0 - 8.79 KG/CM<sup>2</sup>) is required to control the operating pressure for safe operation of this tool. Do not connect this tool to air pressure which can potentially exceed 200 p.s.i. (14 KG/CM<sup>2</sup>) as tool may fracture or burst, possibly causing injury.

### **OPERATING PRESSURE:**

Do not exceed recommended maximum operating pressure as tool wear will be greatly increased. The air supply must be capable of maintaining the operating pressure at the tool. Pressure drops in the air supply can reduce the tool's driving power. Refer to "TOOL SPECIFICATIONS" for setting the correct operating pressure for the tool.

### **FILTER:**

Dirt and water in the air supply are major causes of wear in pneumatic tools. A filter will help to get the best performance and minimum wear from the tool. The filter must have adequate flow capacity for the specific installation. The filter has to be kept clean to be effective in providing clean compressed air to the tool. Consult the manufacturer's instructions on proper maintenance of your filter. A dirty and clogged filter will cause a pressure drop which will reduce the tool's performance.

## LUBRICATION

---

Frequent, but not excessive, lubrication is required for best performance. Oil added through the air line connection will lubricate the internal parts. Use BOSTITCH Air Tool Lubricant, Mobil Velocite #10, or equivalent. Do not use detergent oil or additives as these lubricants will cause accelerated wear to the seals and bumpers in the tool, resulting in poor tool performance and frequent tool maintenance.

If no airline lubricator is used, add oil during use into the air fitting on the tool once or twice a day. Only a few drops of oil at a time is necessary. Too much oil will only collect inside the tool and will be noticeable in the exhaust cycle.

### **COLD WEATHER OPERATION:**

For cold weather operation, near and below freezing, the moisture in the air line may freeze and prevent tool operation. We recommend the use of BOSTITCH WINTER FORMULA air tool lubricant or permanent antifreeze (ethylene glycol) as a cold weather lubricant.

**CAUTION:** Do not store tools in a cold weather environment to prevent frost or ice formation on the tools operating valves and mechanisms that could cause tool failure.

**NOTE:** Some commercial air line drying liquids are harmful to "O"-rings and seals – do not use these low temperature air dryers without checking compatibility.

# LOADING THE N88

**⚠WARNING:**

**EYE PROTECTION** which conforms to ANSI specifications and provides protection against flying particles both from the **FRONT** and **SIDE** should **ALWAYS** be worn by the operator and others in the work area when loading, operating or servicing this tool. Eye protection is required to guard against flying fasteners and debris, which could cause severe eye injury.



The employer and/or user must ensure that proper eye protection is worn. Eye protection equipment must conform to the requirements of the American National Standards Institute, ANSI Z87.1-1989 and provide both frontal and side protection. **NOTE:** Non-side shielded spectacles and face shields alone do not provide adequate protection.

**⚠WARNING:**

**TO PREVENT ACCIDENTAL INJURIES:**

- Never place a hand or any other part of the body in nail discharge area of tool while the air supply is connected.
- Never point the tool at anyone else.
- Never engage in horseplay.
- Never pull the trigger unless nose is directed at the work.
- Always handle the tool with care.
- Do not pull the trigger or depress the trip mechanism while loading the tool.

## N88WW

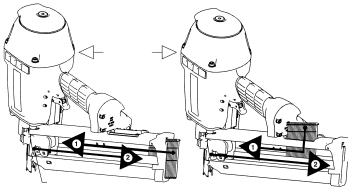

1. Load nails.

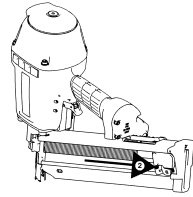

2. Pull pusher back all the way.

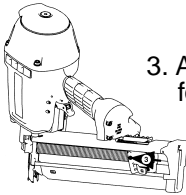

3. Allow pusher spring to pull the pusher forward until it contacts the last nail.

## N88RH

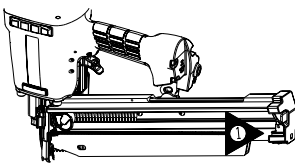

**1. Open the magazine:**

Pull pusher back to engage the latch.

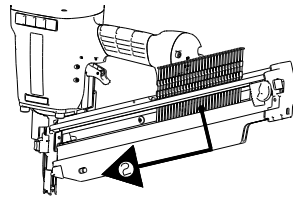

**2. Load Nails:**

Hold nailer down with magazine tilted downward. Insert stick of nails

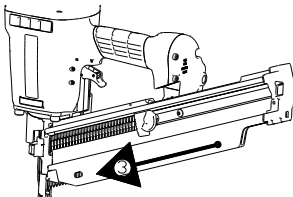

**3. Close Magazine:**

Release pusher by first pulling back on the pusher and then pressing the pusher release tab. Slide pusher against nails.

**NOTE:** Use only nails recommended for use in Bostitch N88 series nailers or nails which meet the Bostitch specifications.

## FASTENER DEPTH CONTROL ADJUSTMENT

The Fastener Depth Control Adjustment feature provides control of the nail drive depth from flush with or just above the work surface to shallow or deep countersink.

**⚠WARNING:** TO ADJUST THE FASTENER

### DEPTH CONTROL:

DISCONNECT TOOL FROM AIR SUPPLY BEFORE ATTEMPTING ANY PARTS DISASSEMBLY AND BEFORE CHANGING THE WORK CONTACTING ELEMENT ADJUSTMENT.

1. Push in on locking button.
2. Adjust contact arm up to increase depth of drive or down to decrease it.
3. Release locking button.

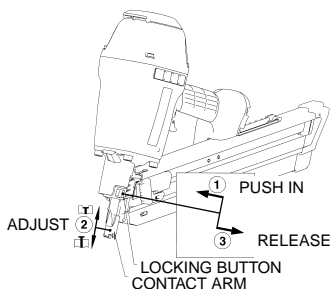

## DIRECTIONAL EXHAUST DEFLECTOR

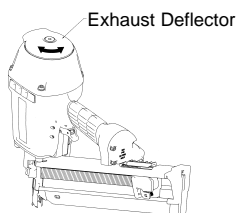

The adjustable exhaust deflector can be rotated into any desired position by hand without the use of any tools.

**NOTE:** N88 Series share the same tool free adjustable exhaust deflector.

## REMOVING NAILS

### **N88WW**

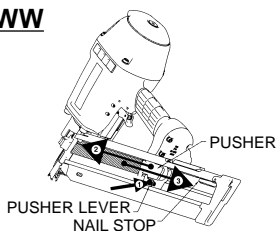

1. Push down on pusher lever
2. Allow pusher spring to pull the pusher forward until it stops in the forward position
3. Slide the nails back to the nail stop

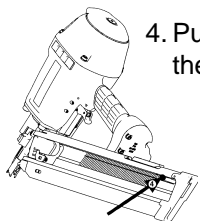

4. Push down on the nail stop

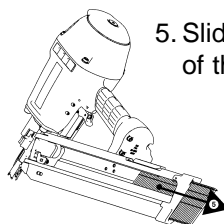

5. Slide the nails out of the magazine

### **N88RH**

1. Pull pusher back until it engages latch.
2. Slide nails back to opening and push out.

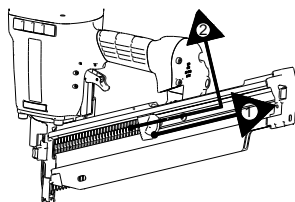

**⚠WARNING:**



**EYE PROTECTION** which conforms to ANSI specifications and provides protection against flying particles both from the **FRONT** and **SIDE** should **ALWAYS** be worn by the operator and others in the work area when loading, operating or servicing this tool. Eye protection is required to guard against flying fasteners and debris, which could cause severe eye injury.

The employer and/or user must ensure that proper eye protection is worn. Eye protection equipment must conform to the requirements of the American National Standards Institute, ANSI Z87.1-1989 and provide both frontal and side protection. **NOTE:** Non-side shielded spectacles and face shields alone do not provide adequate protection.

**BEFORE HANDLING OR OPERATING THIS TOOL:**

- I. READ AND UNDERSTAND THE WARNINGS CONTAINED IN THIS MANUAL.**
- II. REFER TO “TOOL SPECIFICATIONS” IN THIS MANUAL TO IDENTIFY THE OPERATING SYSTEM ON YOUR TOOL.**

There are three available systems on BOSTITCH pneumatic tools. They are:

- 1. CONTACT TRIP OPERATION**
- 2. SEQUENTIAL TRIP OPERATION**

OPERATION

**1. CONTACT TRIP OPERATION**

The CONTACT TRIP MODEL tool contains a contact trip that operates in conjunction with the trigger to drive a fastener. There are two methods of operation to drive fasteners with a contact trip tool.

- A. SINGLE FASTENER PLACEMENT:** To operate the tool in this manner, first position the contact trip on the work surface, **WITHOUT PULLING THE TRIGGER**. Depress the contact trip until the nose touches the work surface and then pull the trigger to drive a fastener. Do not press the tool against the work with extra force. Instead, allow the tool to recoil off the work surface to avoid a second unwanted fastener. Remove your finger from the trigger after each operation.
- B. RAPID FASTENER OPERATION:** To operate the tool in this manner, hold the tool with the contact trip pointing towards but not touching the work surface. Pull the trigger and then tap the contact trip against the work surface using a bouncing motion. Each depression of the contact trip will cause a fastener to be driven.

**⚠WARNING:**

**The operator must not hold the trigger pulled on contact trip tools except during fastening operation, as serious injury could result if the trip accidentally contacted someone or something, causing the tool to cycle.**

**⚠WARNING:**

**Keep hands and body away from the discharge area of the tool. A contact trip tool may bounce from the recoil of driving a fastener and an unwanted second fastener may be driven, possibly causing injury.**

**2. SEQUENTIAL TRIP OPERATION:**

The SEQUENTIAL TRIP MODEL contains a contact trip that operates in conjunction with the trigger to drive a fastener. To operate a sequential trip tool, first position the contact trip on the work surface **WITHOUT PULLING THE TRIGGER**. Depress the contact trip and then pull the trigger to drive a fastener. As long as the contact trip is contacting the work and is held depressed, the tool will drive a fastener each time the trigger is depressed. If the contact trip is allowed to leave the work surface, as is typical with normal tool recoil, the sequence described above must be repeated to drive another fastener.



# TOOL OPERATION CHECK:

---

**CAUTION:** Remove all fasteners from tool before performing tool operation check.

## **1. CONTACT TRIP OPERATION:**

- A. With finger off the trigger, press the contact trip against the work surface.  
**THE TOOL MUST NOT CYCLE.**
- B. Hold the tool off the work surface, and pull the trigger.  
**THE TOOL MUST NOT CYCLE.**
- C. With the tool off the work surface, pull the trigger.  
Press the contact trip against the work surface.  
**THE TOOL MUST CYCLE.**
- D. Without touching the trigger, press the contact trip against the work surface,  
then pull the trigger.  
**THE TOOL MUST CYCLE.**

## **2. SEQUENTIAL TRIP OPERATION:**

- A. Press the contact trip against the work surface, without touching the trigger.  
**THE TOOL MUST NOT CYCLE.**
- B. Hold the tool off the work surface and pull the trigger.  
**THE TOOL MUST NOT CYCLE.**  
Release the trigger. The trigger must return to the trigger stop on the frame.
- C. Pull the trigger and press the contact trip against the work surface.  
**THE TOOL MUST NOT CYCLE.**
- D. With finger off the trigger, press the contact trip against the work surface. Pull the trigger.  
**THE TOOL MUST CYCLE.**

---

## **IN ADDITION TO THE OTHER WARNINGS CONTAINED IN THIS MANUAL OBSERVE THE FOLLOWING FOR SAFE OPERATION**

- Use the BOSTITCH pneumatic tool only for the purpose for which it was designed.
- Never use this tool in a manner that could cause a fastener to be directed toward the user or others in the work area.
- Do not use the tool as a hammer.
- Always carry the tool by the handle. Never carry the tool by the air hose.
- Do not alter or modify this tool from the original design or function without approval from BOSTITCH, INC.
- Always be aware that misuse and improper handling of this tool can cause injury to yourself and others.
- Never clamp or tape the trigger or contact trip in an actuated position.
- Never leave a tool unattended with the air hose attached.
- Do not operate this tool if it does not contain a legible WARNING LABEL.
- Do not continue to use a tool that leaks air or does not function properly. Notify your nearest Bostitch representative if your tool continues to experience functional problems.

# MAINTAINING THE PNEUMATIC TOOL

---

**⚠WARNING:** When working on air tools, note the warnings in this manual and use extra care evaluating problem tools.

**CAUTION:** Pusher spring (constant force spring). Caution must be used when working with the spring assembly. The spring is wrapped around, but not attached to, a roller. If the spring is extended beyond its length, the end will come off the roller and the spring will roll up with a snap, with a chance of pinching your hand. Also the edges of the spring are very thin and could cut. Care must also be taken to insure no permanent kinks are put in the spring as this will reduce the springs force.

## **REPLACEMENT PARTS:**

BOSTITCH replacement parts are recommended. Do not use modified parts or parts which will not give equivalent performance to the original equipment.

## **ASSEMBLY PROCEDURE FOR SEALS:**

When repairing a tool, make sure the internal parts are clean and lubricated. Use MagnaLube or equivalent on all "O"-rings. Coat each "O"-ring with lubricant before assembling. Use a small amount of oil on all moving surfaces and pivots. After reassembly add a few drops of BOSTITCH Air Tool Lubricant through the air line fitting before testing.

## **AIR SUPPLY-PRESSURE AND VOLUME:**

Air volume is as important as air pressure. The air volume supplied to the tool may be inadequate because of undersize fittings and hoses, or from the effects of dirt and water in the system. Restricted air flow will prevent the tool from receiving an adequate volume of air, even though the pressure reading is high. The results will be slow operation, misfeeds or reduced driving power. Before evaluating tool problems for these symptoms, trace the air supply from the tool to the supply source for restrictive connectors, swivel fittings, low points containing water and anything else that would prevent full volume flow of air to the tool.

# TROUBLE SHOOTING

PROBLEM	CAUSE	CORRECTION	
<b>Trigger valve housing leaks air</b>	O-ring cut or cracked	.Replace O-ring	
<b>Trigger valve stem leaks air</b>	O-ring/seals cut or cracked	.Replace trigger valve assembly	
<b>Frame/nose leaks air</b>	Loose nose screws	.Tighten and recheck	
	O-ring or Gasket is cut or cracked	.Replace O-ring or gasket	
	Bumper cracked/worn	.Replace bumper	
<b>Frame/cap leaks air</b>	Damaged gasket or seal	.Replace gasket or seal	
	Cracked/worn head valve bumper	.Replace bumper	
	Loose cap screws	.Tighten and recheck	
<b>Failure to cycle</b>	Air supply restriction	.Check air supply equipment	
	Tool dry, lack of lubrication	.Use BOSTITCH Air Tool Lubricant	
	Worn head valve O-rings	.Replace O-rings	
	Broken cylinder cap spring	.Replace cylinder cap spring	
<b>Lack of power; slow to cycle</b>	Head valve stuck in cap	.Disassemble/Check/Lubricate	
	Tool dry, lacks lubrication	.Use BOSTITCH Air Tool Lubricant	
	Broken cylinder cap spring	.Replace cap spring	
	O-rings/seals cut or cracked	.Replace O-rings/seals	
	Exhaust blocked	.Check bumper, head valve spring, muffler	
	Trigger assembly worn/leaks	.Replace trigger assembly	
	Dirt/tar build up on driver	.Disassemble nose/driver to clean	
	Cylinder sleeve not seated correctly		
	on bottom bumper	.Disassemble to correct	
	Head valve dry	.Disassemble/lubricate	
	Air pressure too low	.Check air supply equipment	
	<b>Skipping fasteners; intermittent feed</b>	Worn bumper	.Replace bumper
		Tar/dirt in driver channel	.Disassemble and clean nose and driver
Air restriction/inadequate air flow through quick disconnect socket and plug		.Replace quick disconnect fittings	
Worn piston O-ring		.Replace O-ring, check driver	
Tool dry, lacks lubrication		.Use BOSTITCH Air Tool Lubricant	
Damaged pusher spring		.Replace spring	
Low air pressure		.Check air supply system to tool	
Loose magazine nose screws		.Tighten all screws	
Fasteners too short for tool		.Use only recommended fasteners	
Bent fasteners		.Discontinue using these fasteners	
Wrong size fasteners		.Use only recommended fasteners	
Leaking head cap gasket		.Tighten screws/replace gasket	
Trigger valve O-ring cut/worn		.Replace O-ring	
Broken/chipped driver		.Replace driver (check piston O-ring)	
Dry/dirty magazine		.Clean/lubricate use BOSTITCH Air Tool Lubricant	
<b>Fasteners jam in tool</b>		Worn magazine	.Replace magazine
		Driver channel worn	.Replace nose/check door
	Wrong size fasteners	.Use only recommended fasteners	
	Bent fasteners	.Discontinue using these fasteners	
	Loose magazine/nose screws	.Tighten all screws	
Broken/chipped driver	.Replace driver		

# N88 DRIVER MAINTENANCE INSTRUCTIONS

Worn driver causing poor quality or loss of power:

- Wear on the driving tip will affect the nail drive, giving symptoms of bent and incompletely driven nails, and damaged nail heads.
- The driver length may be adjusted to allow the driving tip to be redressed to compensate for wear. Heat and precise measurement are required. Contact a qualified service technician for this adjustment.
- The length setting for a new driver is shown below. Measurement is from the bottom face of the main piston.
- Note that the measurement from the top of the piston gives the maximum amount the driver may be adjusted to allow redressing. Always extend the driver the minimum required to allow redressing to restore the driving end; several redressings will be possible before this maximum depth is reached.

## **N88WW**

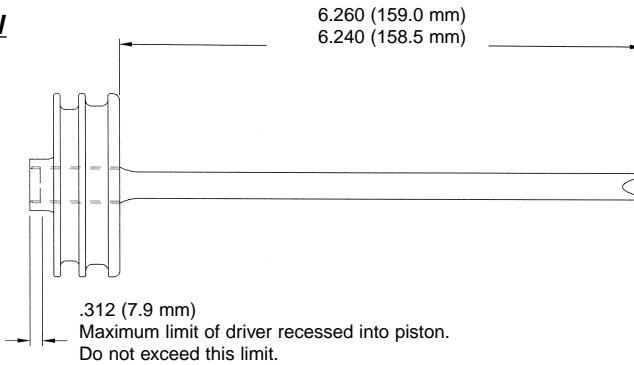

## **N88RH**

